



GeForce RTX 3090

User Guide

TABLE OF CONTENTS

TABLE OF CONTENTS	ii
01 INTRODUCTION	3
About This Guide.....	3
System Specifications.....	4
02 UNPACKING	5
Equipment.....	5
03 Hardware Installation	7
Safety Instructions.....	7
Before You Begin.....	8
Installing the GeForce Graphics Card.....	8
04 SOFTWARE INSTALLATION	12
GeForce Experience Software Installation.....	12
05 CONFIGURING HDMI	14
Enabling Audio Over HDMI.....	14
06 Compliances	15
UNITED STATES Federal Communications Commission (FCC).....	16
Canada.....	17
EUROPEAN UNION.....	17
Australia/New Zealand.....	18
Great Britain (England, Wales and Scotland).....	18
JAPAN.....	19
KOREA.....	21
Taiwan.....	22
China.....	24
India.....	25
Ukraine.....	26
Morocco.....	26

01

INTRODUCTION

Thank you for choosing the NVIDIA® GeForce RTX™ 3090 graphics card.

The GeForce RTX™ 3090 is a big ferocious GPU (BFGPU) with TITAN class performance. It's powered by Ampere—NVIDIA's 2nd gen RTX architecture—doubling down on ray tracing and AI performance with enhanced Ray Tracing (RT) Cores, Tensor Cores, and new streaming multiprocessors. Plus, it features a staggering 24 GB of G6X memory, all to deliver the ultimate gaming experience.

About This Guide

This installation guide discusses the installation and operation of the NVIDIA GeForce RTX 3090 graphic card.

System Specifications

> **Motherboard**

PCI Express® graphics slot required with clearance space for an 12.3" (L) x 5.4" (W) x 3-slot card.

> **System Power Supply**

750 W system power supply¹ with two PCIE 8-pin Power Connectors required.

> **Operating System**

- Microsoft® Windows® 10, 64-bit, build 2004, recommended
- Linux® 64-bit

> **Driver Installation**

- 2 GB of available hard disk space required for driver installation
- Internet connection

¹ A lower power rating may work depending on system configuration. Please check with PSU vendor

02

UNPACKING

Prior to unpacking your new NVIDIA GeForce RTX 3090 graphics card, it is important to make sure you meet all the system specifications listed on page 4 for a smooth installation.

Be sure to inspect each piece of equipment shipped in the packing box. If anything is missing or damaged, contact your reseller.

Equipment

The following equipment and documentation are included in the GeForce RTX 3090 graphics card box.



Quick Start Guide

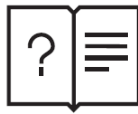

Support Guide



NVIDIA Dual PCIe
12-pin Power Dangle

GeForce RTX 3090 Graphics Card

02

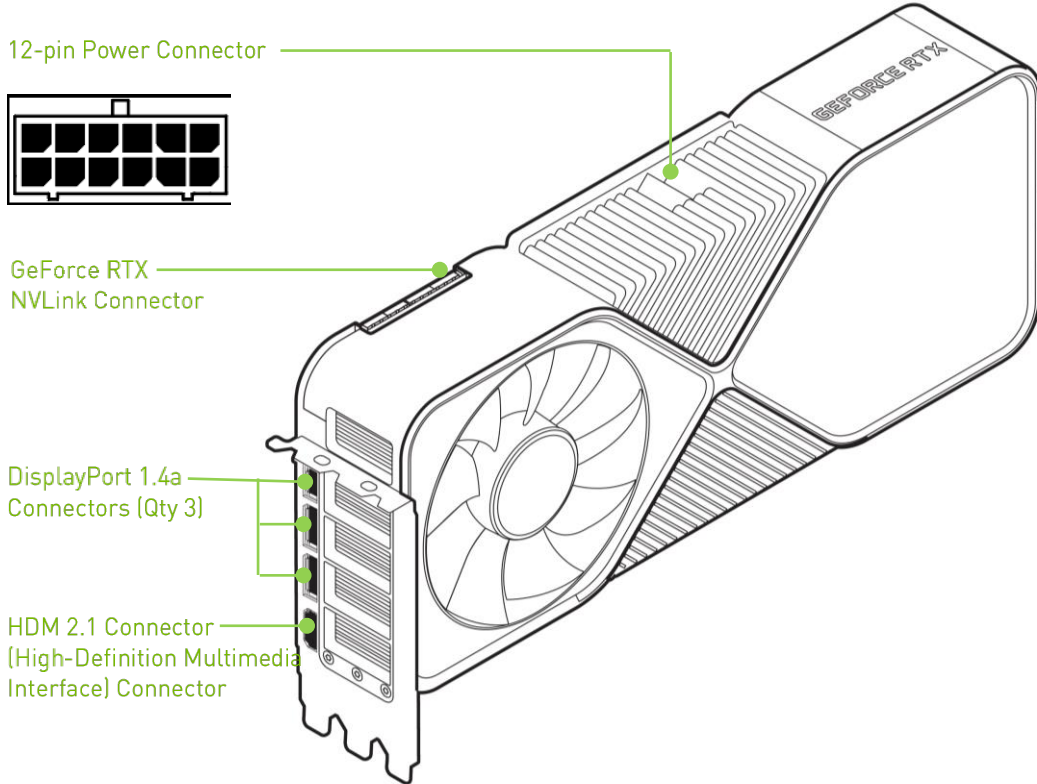

03

HARDWARE INSTALLATION

Installing the NVIDIA GeForce graphics card hardware involves opening your computer. RTX 3090 Follow all the safety instructions provided here to ensure that there is no damage to you, your computer, or the graphics board.

Safety Instructions

To reduce the risk of fire, electric shock, or injury, always follow basic safety precautions.



Note: All hardware must be installed prior to installation of the drivers.

- Remove power from your computer by disconnecting the AC main source before installation.
- Do not install this card with I/O downward.
- Do not operate this product near water or when your hands or body are wet.
- Do not place this product on soft surfaces that could block the ventilation slots and cause overheating.
- Do not place this product near a heating register or radiator.
- Place this product securely on a stable surface. Serious damage to this product may result if it falls.
- Do not allow anything to rest on the power cord. Do not place this product where a person can step or trip on the power cord.

Before You Begin

The GeForce RTX 3090 graphics card is a PCI Express 4.0 ×16 graphics card. Your computer may already have a graphics card installed in the PCI Express slot. If so, you will need to remove that graphics card and replace it with the GeForce RTX 3090 graphics card.

If you do not have a graphics card, this means that your motherboard has on-board graphics (there is a graphics chip installed on your motherboard or integrated in the motherboard chipset). If this is the case, there is no action that needs to be taken before installing your new graphics card.

Use the RTX 3090 graphics card with UL Listed ITE Personal Computer (PC)/Server.

Installing the GeForce Graphics Card

Because there are so many different computer systems on the market, the procedure to install the GeForce RTX 3090 graphics card can vary from system to system. Use the following instructions as a guideline and consult the documentation for your computer system for any further information on your individual system.



Note: It is important that all power to the computer be disconnected before you install the graphics card.

Discharge your body's static electricity by touching a grounded surface before touching the graphics card. A grounded surface is the computer chassis, or some other surface you know to be grounded.



ATTENTION: If your system has been running for a while prior to opening the panels, it is very important that you wait until the graphics card in your system has cooled before taking the card out of the system. Graphics cards get very hot when they have been operating for any length of time.

Use the following procedure to install the GeForce RTX 3090 graphics card into your computer system.

- 1 Turn off your computer and monitor and disconnect the power cord.
Depending on your computer system, you may need to disconnect the cable going to the back of your system. Mark the cables so you can make sure you reconnect them properly.
- 2 Open your computer by removing the cover/side panel. Refer to your computer documentation from the original manufacturer for assistance.
- 3 Remove any existing graphics card (if there is one). Save hardware (such as screws and brackets) to use when installing the NVIDIA graphics card.
- 4 Remove three adjacent slot covers if you do not have a graphics card installed.

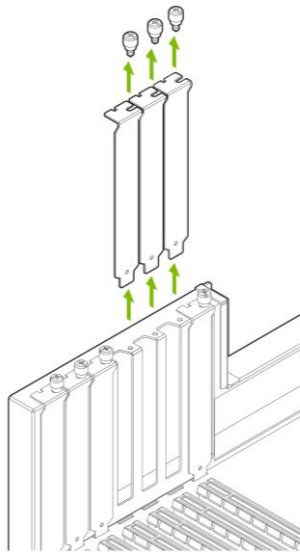

Remove three adjacent slot covers that corresponds to the PCI-Express slot you are installing the GeForce RTX 3090 graphics card in.



Note: The GeForce RTX 3090 card is triple-wide and requires removing three slot covers.

- 5 Plug the GeForce RTX 3090 graphics card into the Primary PCI Express x16 slot on your motherboard. This is often the slot closest to the CPU but may be the second or third slot. Look for the slot labeled x16. It will likely be the only PCI Express slot with a retention lever on the end of the slot or the one closest to the CPU.

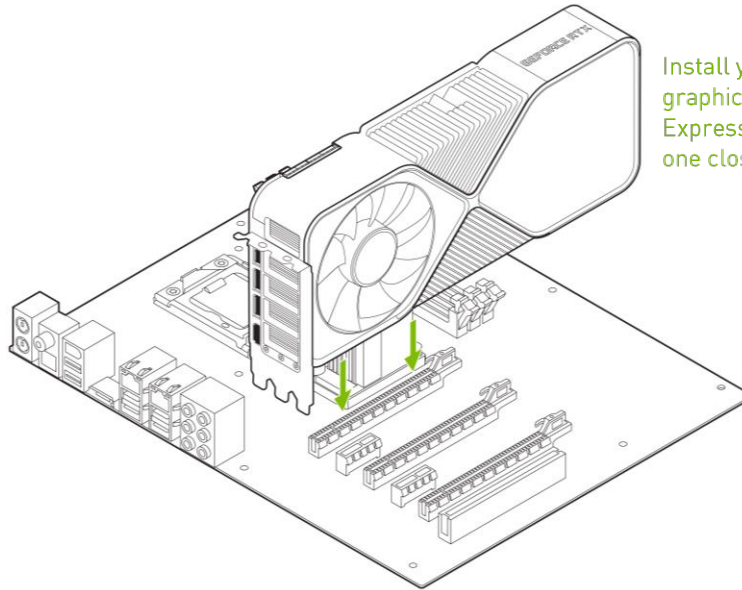

Install your first GeForce RTX 3090 graphics card into the Primary PCI Express x16 slot (the Primary slot is the one closest to the CPU).

! **ATTENTION:** This GPU card should not be installed with the I/O brackets facing downwards.

If you are installing additional GeForce RTX 3090 graphics cards for an SLI configuration, continue with step 6. If you are only installing one Graphics card, go on to step 7

- 6 Install your second GeForce RTX 3090, for 2-way SLI, into the outer PCI Express x16 slot (the outer slot is the one farthest away from the CPU). Connect the two cards together using the GeForce RTX™ NVLink® Bridge 4-slot for 30 Series Products.

! **Note:** Check your motherboard manual for specific details on SLI configuration support and installation.

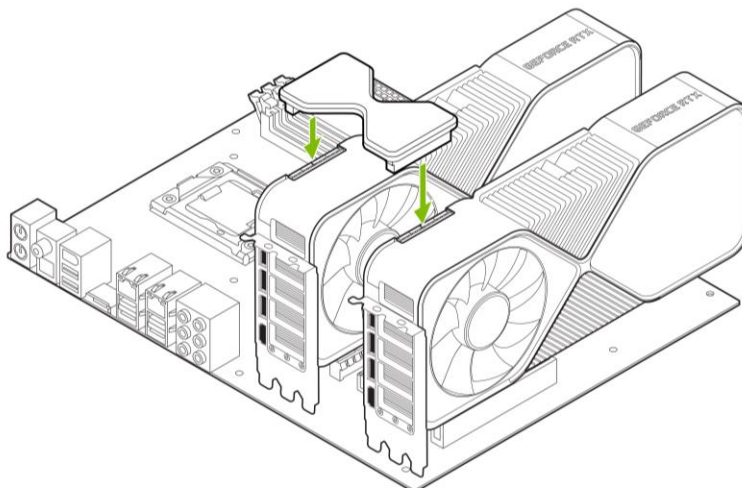

2-way SLI: Install your second GeForce RTX 3090 into the outer PCI Express x16 slot (the outer slot is the one farthest away from the CPU). Connect the two cards together using the GeForce RTX NVLink Bridge 4-slot for 30 Series Products.

! **Note:** GeForce RTX NVLink Bridge 4-slot for 30 Series Products can be found on www.nvidia.com.

- 7 Connect two 8-pin power connectors from the power supply to the NVIDIA Dual PCIe Power Dongle 8-pin connectors.



- 8 Connect the 12-pin connector from the NVIDIA Dual PCIe Power Dongle to the top edge of the GeForce RTX 3090 graphics card.

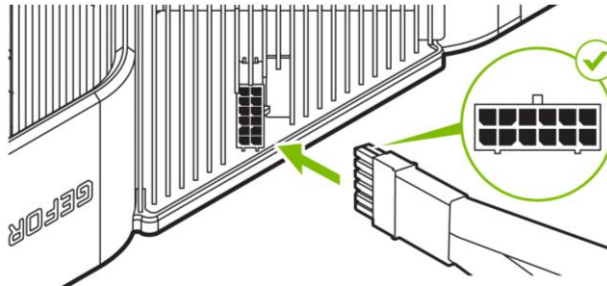

Connect two separate 8-pin PCI Express cables from system power supply to NVIDIA Dual PCIe 8-pin Power Dongle.



ATTENTION: Use only the included NVIDIA Dual PCIe 8-pin Power Dongle with your GeForce RTX 3090 Founders Edition graphics card..

- 9 Reinstall the cover on your computer.
 10 Reconnect the power cord to the PC.
 11 Connect the display(s) to the graphics card.

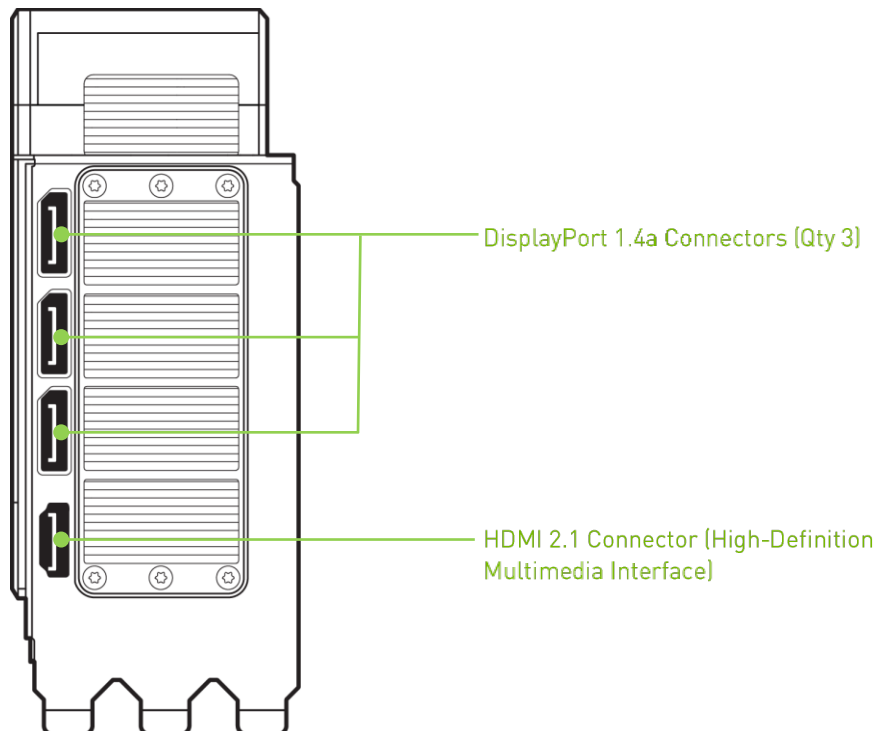

04

SOFTWARE INSTALLATION

With the hardware installed, it is now time to install the NVIDIA GeForce Experience™ software and the graphics driver.

GeForce Experience Software Installation

- 1 Install GeForce Experience software.
 - Go to <http://www.geforce.com/geforce-experience/download> and click **Download Now**.
 - Accept the NVIDIA software license agreement by selecting **Agree and Continue**. GeForce Experience software begins to install.
 - Select **Close** to finish the installation.
- 2 Optimize your installed games.
 - Open GeForce Experience and click **Scan for Games** and click **OK** to scan your installed games.
 - Click on **Optimize All** to optimize your game settings.

- 3 Install the latest drivers.
 - Open GeForce Experience and select the **Drivers** tab.
 - Select **Download Driver**. Your GPU driver begins to download.
 - Select **Express Installation** when the download finishes. GeForce Experience begins to install the graphics driver.



Note: It may take several minutes for the installation to take place. Your screen may go blank for a few seconds one or more times during installation. This is normal.

- Click **CLOSE** when the driver install completes.

Congratulations!

Your GeForce RTX 3090 graphics card is now ready to use!

05

CONFIGURING HDMI

Connecting HDTV via HDMI allows you to output both digital audio and video from your graphics card to an HDTV.

Enabling Audio Over HDMI

If you are connecting to your display over HDMI, you may need to set the HDMI output to be your default audio device.

- 1 Select Start → Control Panel → Sound.
- 2 On the Playback tab, select your HDMI display and select
- 3 Set Default.

Congratulations! Your GeForce graphics card(s) is now ready to use!

For detailed instructions on using the NVIDIA Control Panel, consult the **Control Panel User's Guide** found at www. GeForce.com/drivers (select your driver, then click on **Control Panel User's Guide** to download the User's Guide).

06

COMPLIANCES

The NVIDIA GeForce RTX3090 graphics card (Compliance Model: PG136) is compliant with the following regulations:

- > UNITED STATES Federal Communications Commission (FCC)
 - Federal Communications Commission (FCC)
 - Underwriters Laboratories (UL)
- > Innovation, Science and Economic Development Canada (ISED)
- > European Conformity; Conformité Européenne (CE)
- > Australian Communications and Media Authority (RCM)
- > UK Conformity Assessed (UKCA)
- > Voluntary Control Council for Interference (VCCI)
- > Korea Certification (KC)
- > Bureau of Standards, Metrology & Inspection (BSMI)
- > Ukraine Technical Regulations (UA TR)
- > Moroccan regulatory framework (CMIM)

UNITED STATES

Federal Communications Commission (FCC)



This device complies with part 15 of the FCC Rules. Operation is subject to the following two conditions: (1) this device may not cause harmful interference, and (2) this device must accept any interference received, including any interference that may cause undesired operation of the device.

This equipment has been tested and found to comply with the limits for a Class B digital device, pursuant to Part 15 of the FCC Rules. These limits are designed to provide reasonable protection against harmful interference in a residential installation. This equipment generates uses and can radiate radio frequency energy and, if not installed and used in accordance with the instructions, may cause harmful interference to radio communications.

However, there is no guarantee that interference will not occur in a particular installation.

If this equipment does cause harmful interference to radio or television reception, which can be determined by turning the equipment off and on, the user is encouraged to try to correct the interference by one or more of the following measures:

- > Reorient or relocate the receiving antenna.
- > Increase the separation between the equipment and receiver.
- > Connect the equipment into an outlet on a circuit different from that to which the receiver is connected.
- > Consult the dealer or an experienced radio/TV technician for help.

FCC Warning: The FCC requires that you be notified that any changes or modifications to this device not expressly approved by the manufacturer could void the user's authority to operate the equipment.

Underwriters Laboratories (UL)

I. T. E. ACCESSORY
E204896

CANADA**Innovation, Science and Economic Development Canada (ISED)****CAN ICES-3(B)/NMB-3(B)**

This device complies with Innovation, Science and Economic Development Canada (ISED) license-exempt RSS standard(s). Operation is subject to the following two conditions: (1) this device may not cause interference, and (2) this device must accept any interference, including interference that may cause undesired operation of the device.

Le présent appareil est conforme aux CNR d'Innovation, Sciences et Développement économique Canada applicables aux appareils radio exempts de licence. L'exploitation est autorisée aux deux conditions suivantes : (1) l'appareil ne doit pas produire de brouillage, et (2) l'utilisateur de l'appareil doit accepter tout brouillage radioélectrique subi, même si le brouillage est susceptible d'en compromettre le fonctionnement.

EUROPEAN UNION**European Conformity; Conformité Européenne (CE)**

Santa Clara, California, USA

This device bears the CE mark accordance with Directive 2014/30/EU and 2011/65/EU.

This device complies with the following Directives:

- > EMC Directive 2014/30/EU
- > RoHS Directive 2011/65/EU for hazardous substances

A copy of the Declaration of Conformity to the essential requirements may be obtained directly from NVIDIA GmbH (Bavaria Towers – Blue Tower, Einsteinstrasse 172, D-81677 Munich Germany).

AUSTRALIA/NEW ZEALAND

Australian Communications and Media Authority



This product meets the applicable EMC requirements for Class B, I.T.E equipment and applicable radio equipment requirements

GREAT BRITAIN (ENGLAND, WALES AND SCOTLAND)

UK Conformity Assessed



This device complies with the following Regulations:

- > SI 2016/1091: Electromagnetic Compatibility (EMC)
- > SI 2012/3032: The Restriction of the Use of Certain Hazardous Substances in Electrical and Electronic Equipment (As Amended)

A copy of the Declaration of Conformity to the essential requirements may be obtained directly from NVIDIA Ltd. (100 Brook Drive, 3rd Floor Green Park, Reading RG2 6UJ, United Kingdom).

JAPAN

Voluntary Control Council for Interference (VCCI)



この装置は、クラスB機器です。この装置は、住宅環境で使用することを目的としていますが、この装置がラジオやテレビジョン受信機に近接して使用されると、受信障害を引き起こすことがあります。

取扱説明書に従って正しい取り扱いをして下さい。

VCCI - B

Japan RoHS Material Content Declaration

日本工業規格 JIS C 0950:2008 により、2006年7月1日以降に販売される特定分野の電気および電子機器について、製造者による含有物質の表示が義務付けられます。

機器名称: グラフィックカード

主な分類	特定化学物質記号					
	Pb	Hg	Cd	Cr(VI)	PBB	PBDE
PCB ボード	0	0	0	0	0	0
パッシブ電子部品	除外項目	0	0	0	0	0
アクティブ電子部品	除外項目	0	0	0	0	0
プロセッサ	0	0	0	0	0	0
メモリ	0	0	0	0	0	0
機械部品	除外項目	0	0	0	0	0
ケーブル/コネクタ	除外項目	0	0	0	0	0
はんだ付け材料	0	0	0	0	0	0
フラックス、クリームはんだ、ラベル、その他消耗品	0	0	0	0	0	0

注:

- 「0」は、特定化学物質の含有率が日本工業規格 JIS C 0950:2008 に記載されている含有率基準値より低いことを示します。
- 「除外項目」は、特定化学物質が含有マークの除外項目に該当するため、特定化学物質について、日本工業規格 JIS C 0950:2008 に基づく含有マークの表示が不要であることを示します。
- 「0.1wt%超」または「0.01wt%超」は、特定化学物質の含有率が日本工業規格 JIS C 0950:2008 に記載されている含有率基準値を超えていることを示します。

A Japanese regulatory requirement, defined by specification JIS C 0950: 2008, mandates that manufacturers provide Material Content Declarations for certain categories of electronic products offered for sale after July 1, 2006
Product Model Number: Graphic card

Major Classification	Symbols of Specified Chemical Substance					
	Pb	Hg	Cd	Cr(VI)	PBB	PBDE
PCB	0	0	0	0	0	0
Passive components	Exempt	0	0	0	0	0
Active components	Exempt	0	0	0	0	0
Processor	0	0	0	0	0	0
Memory	0	0	0	0	0	0
Mechanicals	Exempt	0	0	0	0	0
Cables/Connector	Exempt	0	0	0	0	0
Soldering material	0	0	0	0	0	0
Flux, Solder Paste, label, and other consumable materials	0	0	0	0	0	0

Notes:

1. "0" indicates that the level of the specified chemical substance is less than the threshold level specified in the standard, JIS C 0950: 2008.
2. "Exempt" indicates that the specified chemical substance is exempt from marking and it is not required to display the marking for that specified chemical substance per the standard, JIS C 0950: 2008.
3. "Exceeding 0.1wt%" or "Exceeding 0.01wt%" is entered in the table if the level of the specified chemical substance exceeds the threshold level specified in the standard, JIS C 0950: 2008

KOREA

Korea Certification (KC)



R-R-NVA-PG136

B 급 기기	이 기기는 가정용(B 급) 전자파적합기기로서 주로 가정에서 사용하는 것을 목적으로 하며, 모든 지역에서 사용할 수 있습니다.
--------	---

Korea RoHS Material Content Declaration

확인 및 평가 양식은 제품에 포함 된 유해 물질의 허용 기준의 준수에 관한				
문 준비	상호 :	엔비디아홍콩홀딩스리미티드(영업소)	법인등록번호	110181-0036373
	대표자성명	카렌테레사번즈	사업자등록번호:	120-84-06711
	주소	서울특별시 강남구 영동대로 511, 2101 호 (삼성동, 코엑스무역타워)		
제품 내용				
제품의 종류	개인용 컴퓨터	제품명(규격)	그래픽카드	
세부모델명(번호):	해당없음	제품출시일	해당없음	
제품의 중량	해당없음	제조, 수입업자	엔비디아	
엔비디아의 그래픽 카드제품은 전기 전자제품 및 자동차의 자원순환에 관한 법률 시행령 제 11 조 제 1 항에 의거한 법 시행규칙 제 3 조에따른 유해물질함유 기준을 확인 및 평가한 결과, 이를 준수하였음을 공표합니다.				
구비서류 : 없음				
작성방법				
① 제품의 종류는 "전기.전자제품 및 자동차의 자원순환에관한 법률 시행령" 제 8 조 제 1 항 및 제 2 항에 따른 품목별로 구분하여 기재합니다.				
② 전기 전자 제품의 경우 모델명 (번호), 자동차의 경우, 제원관리번호를 기재합니다.				
③ 해당제품의 제조업자 또는 수입업자를 기재합니다.				

Confirmation and Evaluation Form Concerning the Adherence to Acceptable Standards of Hazardous Materials Contained in Products				
Statement Prepared by	Company Name:	NVIDIA HongKong Holding Ltd.Korea branch	Corporate Identification Number:	110181-0036373
	Name of Company Representative:	Karen Theresa Burns	Business Registration Number:	120-84-06711
	Address	2788 San Tomas Expressway, Santa Clara, CA 95051		
Product Information				
Product Category:	PC	Name of Product:	Graphic Card	
Detailed Product Model Name (Number):	N/A	Date of first market release:	N/A	
Weight of Product:	N/A	Manufacturer and/or Importer:	NVIDIA Corporation	
<p>This for is publicly certify That NVIDIA Company has undergone the confirmation and evaluation procedures for the acceptable amounts of hazardous materials contained in graphic card according to the regulations stipulated in Article 3 of the 'Status on the Recycling of Electrical and Electronic Products, and Automobiles' and that company has graphic card adhered to the Enforcement Regulations of Article 11, Item 1 of the statute.</p>				
<p>Attachment: None</p> <p>* Preparing the Form</p> <p>① Please indicate the product category according to the categories listed in Article 8, Items 1and 2 of the ' Enforcement Ordinance of the Statute on the Recycling of Electrical, Electronic and Automobile Materials'</p> <p>② For electrical and electronic products, please indicate the Model Name (and number). For automobiles, please indicate the Vehicle Identification Number.</p> <p>③ Please indicate the name of manufacturer and/or importer of the product.</p>				

TAIWAN

Bureau of Standards, Metrology & Inspection (BSMI)



D33088
RoHS

Taiwan RoHS Material Content Declaration

限用物質含有情況標示聲明書 Declaration of the presence condition of the Restricted Substances Marking						
設備名稱：繪圖卡 Equipment Name: Graphic Card						
單元 Parts	限用物質及其化學符號 Restricted substances and its chemical symbols					
	鉛 (Pb)	汞 (Hg)	鎘 (Cd)	六價鉻 (Cr(VI))	多溴聯苯 (PBB)	多溴二苯醚 (PBDE)
PCB 板 PCB	0	0	0	0	0	0
被動電子零件 Passive components	-	0	0	0	0	0
主動電子零件 Active components	-	0	0	0	0	0
處理器 Processor	0	0	0	0	0	0
內存 Memory	0	0	0	0	0	0
結構件以及風扇 Mechanical parts and Fan	-	0	0	0	0	0
線材/連接器 Cables/Connectors	-	0	0	0	0	0
焊接金屬 Soldering material	0	0	0	0	0	0
助焊劑，錫膏，標籤及耗材 Flux, Solder Paste, label and other consumable materials	0	0	0	0	0	0
<p>備考 1: 0: 系指該限用物質未超出百分比含量基準值 Note 1: 0: indicates that the percentage content of the restricted substance does not exceed the percentage of reference value of presence.</p> <p>備考 2: -: 系指該項限用物質為排外項目。 Note 2: -: indicates that the restricted substance corresponds to the exemption. 此表中所有名稱中含“-”的部件均符合歐盟 RoHS 立法。</p>						

All parts named in this table with an “-” are in compliance with the European Union’s RoHS Legislation.

注：環保使用期限的參考標識取決與產品正常工作的溫度和濕度等條件

Note: The referenced Environmental Protection Use Period Marking was determined according to normal operating use conditions of the product such as temperature and humidity.

CHINA

China RoHS Material Content Declaration



产品中有害物质的名称及含量
The Table of Hazardous Substances and their Content
根据中国《电器电子产品有害物质限制使用管理办法》
as required by Management Methods for Restricted Use of Hazardous Substances in Electrical and Electronic Products

部件名称 Parts	有害物质 Hazardous Substances					
	铅 (Pb)	汞 (Hg)	镉 (Cd)	六价铬 (Cr(VI))	多溴联苯 (PBB)	多溴二苯醚 (PBDE)
PCB 板 PCB	0	0	0	0		0
被动电子零件 Passive components	X	0	0	0	0	0
主动电子零件 Active components	X	0	0	0	0	0
处理器 Processor	0	0	0	0	0	0
结构件以及风扇 Mechanical parts and Fan	X	0	0	0	0	0
线材/连接器 Cables/Connectors	X	0	0	0	0	0
焊接金属 Soldering material	0	0	0	0	0	0
助焊剂, 锡膏, 标签及耗材 Flux, Solder Paste, label and other consumable materials	0	0	0	0	0	0

本表格依据 SJ/T 11364-2014 的规定编制
The table according to SJ/T 11364

○: 表示该有害物质在该部件所有均质材料中的含量均在 GB/T 26572 标准规定的限量要求以下。
○: Indicates that this hazardous substance contained in all of the homogeneous materials for this part is below the limit requirement in GB/T 26572.

X: 表示该有害物质至少在该部件的某一均质材料中的含量超出 GB/T 26572 标准规定的限量要求。

X: Indicates that this hazardous substance contained in at least one of the homogeneous materials used for this part is above the limit requirement in GB/T 26572.

此表中所有名称中含“X”的部件均符合欧盟 RoHS 立法。

All parts named in this table with an “X” are in compliance with the European Union’s RoHS Legislation.

注：环保使用期限的参考标识取决于产品正常工作的温度和湿度等条件

Note: The referenced Environmental Protection Use Period Marking was determined according to normal operating use conditions of the product such as temperature and humidity.

INDIA

India RoHS Material Content Declaration

This product, as well as its related consumables and spares, complies with the reduction in hazardous substances provisions of the “India E-waste (Management and Handling) Rule 2016”. It does not contain lead, mercury, hexavalent chromium, polybrominated biphenyls or polybrominated diphenyl ethers in concentrations exceeding 0.1 weight % and 0.01 weight % for cadmium, except for where allowed pursuant to the exemptions set in Schedule 2 of the Rule.

India RoHS Self-Declaration Form (as per E-Waste (Management) Rules, 2016)								
Sr. No.	Product Category & Code (as Per Schedule I of E-Waste (M) Rules, 2016)	Product Name	Model No.	Product Weight (g)	Date of placing on market	Compliance with RoHS Yes/No	RoHS Information provided on product info booklet Yes/No	In case Product is imported from other country, name of the country manufactured
i.	TEW2 (Graphic Card)	Graphic Card	N/A	N/A	N/A	Yes	Yes	China

UKRAINE

Ukraine Technical Regulations (UA TR)



Цей пристрій відповідає наступним технічним регламентам:

- > Технічного регламенту з електромагнітної сумісності обладнання
- > Технічного регламенту обмеження використання деяких небезпечних речовин в електричному та електронному обладнанні

MOROCCO

Moroccan Regulatory Framework (CMIM)



Notice

The information provided in this specification is believed to be accurate and reliable as of the date provided. However, NVIDIA Corporation ("NVIDIA") does not give any representations or warranties, expressed or implied, as to the accuracy or completeness of such information. NVIDIA shall have no liability for the consequences or use of such information or for any infringement of patents or other rights of third parties that may result from its use. This publication supersedes and replaces all other specifications for the product that may have been previously supplied.

NVIDIA reserves the right to make corrections, modifications, enhancements, improvements, and other changes to this specification, at any time and/or to discontinue any product or service without notice. Customer should obtain the latest relevant specification before placing orders and should verify that such information is current and complete.

NVIDIA products are sold subject to the NVIDIA standard terms and conditions of sale supplied at the time of order acknowledgement, unless otherwise agreed in an individual sales agreement signed by authorized representatives of NVIDIA and customer. NVIDIA hereby expressly objects to applying any customer general terms and conditions with regard to the purchase of the NVIDIA product referenced in this specification.

NVIDIA products are not designed, authorized or warranted to be suitable for use in medical, military, aircraft, space or life support equipment, nor in applications where failure or malfunction of the NVIDIA product can reasonably be expected to result in personal injury, death or property or environmental damage. NVIDIA accepts no liability for inclusion and/or use of NVIDIA products in such equipment or applications and therefore such inclusion and/or use is at customer's own risk.

NVIDIA makes no representation or warranty that products based on these specifications will be suitable for any specified use without further testing or modification. Testing of all parameters of each product is not necessarily performed by NVIDIA. It is customer's sole responsibility to ensure the product is suitable and fit for the application planned by customer and to do the necessary testing for the application in order to avoid a default of the application or the product. Weaknesses in customer's product designs may affect the quality and reliability of the NVIDIA product and may result in additional or different conditions and/or requirements beyond those contained in this specification. NVIDIA does not accept any liability related to any default, damage, costs or problem which may be based on or attributable to: (i) the use of the NVIDIA product in any manner that is contrary to this specification, or (ii) customer product designs.

No license, either expressed or implied, is granted under any NVIDIA patent right, copyright, or other NVIDIA intellectual property right under this specification. Information published by NVIDIA regarding third-party products or services does not constitute a license from NVIDIA to use such products or services or a warranty or endorsement thereof. Use of such information may require a license from a third party under the patents or other intellectual property rights of the third party.

ALL NVIDIA DESIGN SPECIFICATIONS, REFERENCE BOARDS, FILES, DRAWINGS, DIAGNOSTICS, LISTS, AND OTHER DOCUMENTS (TOGETHER AND SEPARATELY, "MATERIALS") ARE BEING PROVIDED "AS IS." NVIDIA MAKES NO WARRANTIES, EXPRESSED, IMPLIED, STATUTORY, OR OTHERWISE WITH RESPECT TO THE MATERIALS, AND EXPRESSLY DISCLAIMS ALL IMPLIED WARRANTIES OF NONINFRINGEMENT, MERCHANTABILITY, AND FITNESS FOR A PARTICULAR PURPOSE. Notwithstanding any damages that customer might incur for any reason whatsoever, NVIDIA's aggregate and cumulative liability towards customer for the products described herein shall be limited in accordance with the NVIDIA terms and conditions of sale for the product.

VESA DisplayPort

DisplayPort and DisplayPort Compliance Logo, DisplayPort Compliance Logo for Dual-mode Sources, and DisplayPort Compliance Logo for Active Cables are trademarks owned by the Video Electronics Standards Association in the United States and other countries.



HDMI, the HDMI logo, and High-Definition Multimedia Interface are trademarks or registered trademarks of HDMI Licensing LLC.

OpenCL

OpenCL is a trademark of Apple Inc. used under license to the Khronos Group Inc.

MPEG LA (H.264/AVC)

THIS PRODUCT IS LICENSED UNDER THE AVC PATENT PORTFOLIO LICENSE FOR THE PERSONAL USE OF A CONSUMER OR OTHER USES IN WHICH IT DOES NOT RECEIVE REMUNERATION TO (i) ENCODE VIDEO IN COMPLIANCE WITH THE AVC STANDARD ("AVC VIDEO") AND/OR (ii) DECODE AVC VIDEO THAT WAS ENCODED BY A CONSUMER ENGAGED IN A PERSONAL ACTIVITY AND/OR WAS OBTAINED FROM A VIDEO PROVIDER LICENSED TO PROVIDE AVC VIDEO. NO LICENSE IS GRANTED OR SHALL BE IMPLIED FOR ANY OTHER USE. ADDITIONAL INFORMATION MAY BE OBTAINED FROM MPEG LA, L.L.C. SEE [HTTP://WWW.MPEGLA.COM](http://www.mpegla.com).

Trademarks

NVIDIA, the NVIDIA logo, NVIDIA CUDA, NVIDIA GeForce, GeForce RTX, GeForce Experience, NVIDIA NVLink, GigaThread, Lumenex, PureVideo, and PhysX Technology are trademarks or registered trademarks of NVIDIA Corporation. Other company product names may be trademarks of the respective companies with which they are associated.

Copyright

© 2021 NVIDIA Corporation. All rights reserved.

